

# Technics®



## EAH-F70N

Digital Wireless Stereo Headphones  
Owner's Manual

Thank you for purchasing this product.

Please read these instructions carefully before using this product, and save this manual for future use.

#### **For the U.S.A. customers**

If you have any questions, visit:  
<http://shop.panasonic.com/support>

Register online at <http://shop.panasonic.com/support> (U.S. customers only)

#### **For the United Kingdom and Ireland customers**

##### **Sales and Support Information**

###### Customer Communications Centre

- For customers within the UK: 0333 222 8777
- For customers within Ireland: 01 447 5229
- Monday–Friday 9:00 am–5:00 pm (Excluding public holidays).
- For further support on your product, please visit our website: [www.technics.com/uk/](http://www.technics.com/uk/)

# IMPORTANT SAFETY INSTRUCTIONS

Read these operating instructions carefully before using the unit. Follow the safety instructions on the unit and the applicable safety instructions listed below. Keep these operating instructions handy for future reference.

- 1 Read these instructions.
- 2 Keep these instructions.
- 3 Heed all warnings.
- 4 Follow all instructions.
- 5 Do not use this apparatus near water.
- 6 Clean only with dry cloth.
- 7 Do not block any ventilation openings. Install in accordance with the manufacturer's instructions.
- 8 Do not install near any heat sources such as radiators, heat registers, stoves, or other apparatus (including amplifiers) that produce heat.
- 9 Do not defeat the safety purpose of the polarized or grounding-type plug. A polarized plug has two blades with one wider than the other. A grounding-type plug has two blades and a third grounding prong. The wide blade or the third prong are provided for your safety. If the provided plug does not fit into your outlet, consult an electrician for replacement of the obsolete outlet.
- 10 Protect the power cord from being walked on or pinched particularly at plugs, convenience receptacles, and the point where they exit from the apparatus.
- 11 Only use attachments/accessories specified by the manufacturer.
- 12 Use only with the cart, stand, tripod, bracket, or table specified by the manufacturer, or sold with the apparatus. When a cart is used, use caution when moving the cart/apparatus combination to avoid injury from tip-over.
- 13 Unplug this apparatus during lightning storms or when unused for long periods of time.
- 14 Refer all servicing to qualified service personnel. Servicing is required when the apparatus has been damaged in any way, such as power-supply cord or plug is damaged, liquid has been spilled or objects have fallen into the apparatus, the apparatus has been exposed to rain or moisture, does not operate normally, or has been dropped.



# Safety precautions

## For the U.S.A. only



A lithium ion battery that is recyclable powers the product you have purchased. Please call 1-800-8-BATTERY for information on how to recycle this battery.

## THE FOLLOWING APPLIES ONLY IN THE U.S.A.

This device complies with Part 15 of FCC Rules. Operation is subject to the following two conditions:

- (1) This device may not cause harmful interference, and
- (2) this device must accept any interference received, including interference that may cause undesired operation.

FCC ID: ACJ-EAH-F70N

Model: EAH-F70N

This transmitter must not be co-located or operated in conjunction with any other antenna or transmitter.

This equipment complies with FCC radiation exposure limits set forth for an uncontrolled environment and meets the FCC radio frequency (RF) Exposure Guidelines. This equipment has very low levels of RF energy that is deemed to comply without testing of specific absorption rate (SAR).

## THE FOLLOWING APPLIES ONLY IN THE U.S.A.

### FCC Note:

This equipment has been tested and found to comply with the limits for a Class B digital device, pursuant to Part 15 of the FCC Rules.

These limits are designed to provide reasonable protection against harmful interference in a residential installation. This equipment generates, uses, and can radiate radio frequency energy and, if not installed and used in accordance with the instructions, may cause harmful interference to radio communications.

However, there is no guarantee that interference will not occur in a particular installation. If this equipment does cause harmful interference to radio or television reception, which can be determined by turning the equipment off and on, the user is encouraged to try to correct the interference by one or more of the following measures:

- Reorient or relocate the receiving antenna.
- Increase the separation between the equipment and receiver.
- Connect the equipment into an outlet on a circuit different from that to which the receiver is connected.
- Consult the dealer or an experienced radio/TV technician for help.

Any unauthorized changes or modifications to this equipment would void the user's authority to operate this device.

This device complies with Part 15 of the FCC Rules. Operation is subject to the following two conditions: (1) This device may not cause harmful interference, and (2) this device must accept any interference received, including interference that may cause undesired operation.

Suppliers Declaration of Conformity

Trade Name: Technics

Model No.: EAH-F70N

Responsible Party: Panasonic Corporation of North America  
Two Riverfront Plaza, Newark, NJ 07102-5490

Support Contact: <http://shop.panasonic.com/support>

**FC** Technics  
EAH-F70N

## ■ Unit

### **WARNING:**

**To reduce the risk of fire, electric shock or product damage,**

- **Do not expose this unit to rain, moisture, dripping or splashing.**
- **Do not place objects filled with liquids, such as vases, on this unit.**
- **Use the recommended accessories.**
- **Do not remove covers.**
- **Do not repair this unit by yourself. Refer servicing to qualified service personnel.**

### **Avoid the use in the following conditions**

- High or low extreme temperatures during use, storage or transportation.
  - Disposal of a battery into fire or a hot oven, or mechanically crushing or cutting of a battery, that can result in an explosion.
  - Extremely high temperature and/or extremely low air pressure that can result in an explosion or the leakage of flammable liquid or gas.
- Avoid using or placing this unit near sources of heat.
  - Do not listen with this unit at high volume in places where you need to hear sounds from the surrounding environment for safety, such as at railroad crossings, and construction sites.
  - Wide band characteristic voltage equal or larger than 75 mV.
  - Keep this unit away from something susceptible to the magnetism. Such devices as a clock may not operate correctly.
  - When using this unit in an airplane, heed the instructions given by the airline company. Some airlines may forbid your using the unit. For further details, contact the airline you will be flying with.

## ■ Allergies

- Discontinue use if you experience discomfort with the ear pads or any other parts that directly contact your skin.
- Continued use may cause rashes or other allergic reactions.

## ■ Precautions for listening with the Headphones

- Excessive sound pressure from earphones and headphones can cause hearing loss.
- Do not use your headphones at a high volume. Hearing experts advise against continuous extended play.
- If you experience a ringing in your ears, reduce volume or discontinue use.
- Do not use while operating a motorised vehicle. It may create a traffic hazard and is illegal in many areas.
- You should use extreme caution or temporarily discontinue use in potentially hazardous situations.

This unit may receive radio interference caused by mobile telephones during use. If such interference occurs, please increase separation between this unit and the mobile telephone.

Keep the airplane adaptor out of reach of children to prevent swallowing.

Use only the supplied USB charging cord when connecting to a computer.

This unit is intended for use in moderate and tropical climates.



CONFORMS TO  
UL STD. 60065

**Intertek**

3123480

---

# About Bluetooth®

**Panasonic bears no responsibility for data and/or information that is compromised during a wireless transmission.**

## ■ Frequency band used

This unit uses the 2.4 GHz frequency band.

## ■ Certification of this unit

- This unit conforms to frequency restrictions and has received certification based on frequency laws. Thus, a wireless permit is not necessary.
- The actions below are punishable by law in some countries:
  - Taking apart/modifying this unit.
  - Removing specification indications.

## ■ Restrictions of use

- Wireless transmission and/or usage with all Bluetooth® equipped devices is not guaranteed.
- All devices must conform to standards set by Bluetooth SIG, Inc.
- Depending on the specifications and settings of a device, it can fail to connect or some operations can be different.
- This unit supports Bluetooth® security features. But depending on the operating environment and/or settings, this security may not be sufficient. Transmit data wirelessly to this unit with caution.
- This unit cannot transmit data to a Bluetooth® device.

## ■ Range of use

Use this unit at a maximum range of 10 m (33 ft.).

The range can decrease depending on the environment, obstacles or interference.

## ■ Interference from other devices

- This unit may not function properly and troubles such as noise and sound jumps may arise due to radio wave interference if this unit is located too close to other Bluetooth® devices or the devices that use the 2.4 GHz band.
- This unit may not function properly if radio waves from a nearby broadcasting station, etc. is too strong.

## ■ Intended usage

- This unit is for normal, general use only.
- Do not use this system near an equipment or in an environment that is sensitive to radio frequency interference (example: airports, hospitals, laboratories, etc.).

---

# Table of contents

IMPORTANT SAFETY INSTRUCTIONS .....	2
Safety precautions .....	3
About Bluetooth® .....	5
<b>Before use</b>	
<hr/>	
Accessories .....	7
Maintenance.....	7
Part names.....	8
<b>Preparation</b>	
<hr/>	
Charging.....	9
Turning the power on/off .....	9
Connecting a Bluetooth® device.....	10
• Pairing (Registration) this unit with the Bluetooth® device for connection .....	10
• Connecting a paired Bluetooth® device .....	11
<b>Operation</b>	
<hr/>	
Listening to music .....	12
• Remote controlling.....	12
Making a phone call .....	13
Using noise cancelling .....	14
Useful functions.....	15
• Activating voice functions .....	15
• Guidance messages.....	15
• Using wearing playback.....	15
• Using the ambient sound enhancer.....	16
• Making a multi-point connection .....	17
• Battery level notification.....	18
• Auto power off .....	18
• Using the detachable cord (supplied).....	18
• Resetting the unit .....	18
<b>Other</b>	
<hr/>	
Storage of the unit.....	19
Restoring to the factory settings.....	20
Copyright, etc. ....	20
Troubleshooting.....	21
• Sound and audio volume.....	21
• Bluetooth® device connection.....	21
• Phone Calls .....	21
• General.....	22
• Power supply and charging .....	22
• Guidance messages.....	22
• Wearing playback .....	22
Specifications .....	23
To remove the battery when disposing of this unit .....	24

## Expressions used in this document

- Pages to be referred to are indicated as “→ ○○”.
- The product illustrations may differ from the actual product.

## Accessories

Please check and identify the supplied accessories.

**Only for U.S.A.:**

To order accessories, refer to “Limited Warranty” on “Basic Owner’s Manual”.

**1 x USB charging cord**

**1 x Detachable cord**

**1 x Carrying case**



**1 x Airplane adaptor**

## Maintenance

Clean this unit with a dry and soft cloth.

- Do not use solvents including benzine, thinner, alcohol, kitchen detergent, a chemical wiper, etc. This might cause the exterior case to be deformed or the coating to come off.

Keeping the battery performance

- During the long period of disuse, full charge this unit once every 6 months to keep the battery performance.

## Part names

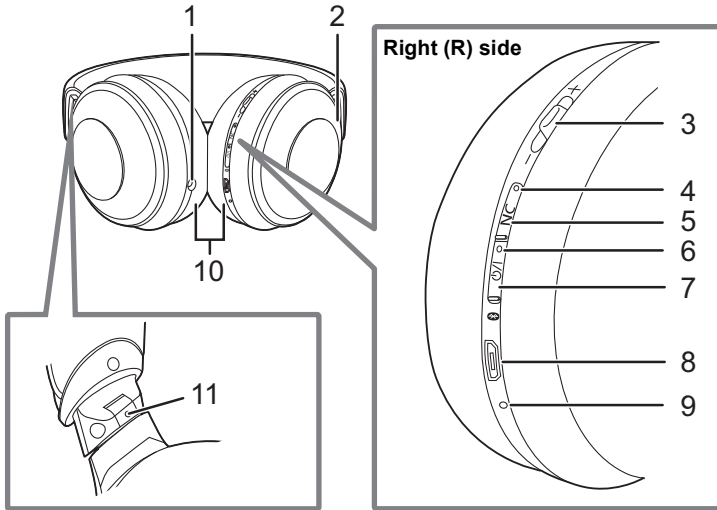

- |   |   |
|---|---|
| <p>1 Audio input terminal</p> <p>2 Ambient sound enhancer sensor panel<br/>(→ 16, “Using the ambient sound enhancer”)</p> <p>3 Multiple functions button</p> <ul style="list-style-type: none"> <li>You can perform a wide variety of operations by pressing this button or moving it toward the “+” or “-” side. (→ 12, “Remote controlling”)</li> </ul> <p>4 Noise cancelling LED<sup>*1</sup></p> <p>5 [NC] (Noise cancelling) button (→ 14, “Using noise cancelling”, → 16, “Using the ambient sound enhancer”)</p> | <p>6 Power/pairing LED<sup>*2</sup></p> <p>7 [P/I] ([P/I]) button<sup>*3</sup></p> <p>8 Charging terminal (DC IN)</p> <ul style="list-style-type: none"> <li>Connect the USB charging cord (supplied) to this terminal when charging. (→ 9, “Charging”)</li> </ul> <p>9 Microphone</p> <p>10 Ear pads</p> <p>11 Raised dot indicating the left side</p> |
|---|---|

### \*1 Examples of lighting/blinking patterns

Lighting (green):	Noise cancelling is ON
-------------------	------------------------

- If wearing playback (→ 15, “Using wearing playback”) has been enabled, the lights go out when you are wearing this unit.

### \*2 Examples of lighting/blinking patterns

Lighting (red):	Charging is in progress
Lighting alternately in blue and red:	Bluetooth® pairing (registration) standby
Blinking slowly (blue) <sup>*4</sup> :	Bluetooth® connection standby
Blinking twice about every 2 seconds (blue) <sup>*4</sup> :	A Bluetooth® pairing (registration) has been established or a call is in progress
Blinking (blue) <sup>*4</sup> :	A call is being received

- If wearing playback (→ 15, “Using wearing playback”) has been enabled, the lights go out when you are wearing this unit.

\*3 P/I: Standby/ON

\*4 The battery is low when it is blinking in red. (→ 18, “Battery level notification”)



## Charging

The rechargeable battery (installed in the unit) is not charged initially. Charge the battery before using the unit.

### Connect this unit to a computer using the USB charging cord.

- A:** Power/pairing LED
- B:** USB charging cord (supplied)
  - Check the direction of the terminals and plug in/out straight holding onto the plug. (It may result in malfunction by the deforming of the terminal if it is plugged in obliquely or in wrong direction.)

- C:** Computer
  - Turn on the computer in advance.

- The power/pairing LED lights in red when charging is in progress. When charging is completed, the power/pairing LED will go out.
- It takes approx. 4 hours to charge the battery from empty to full.

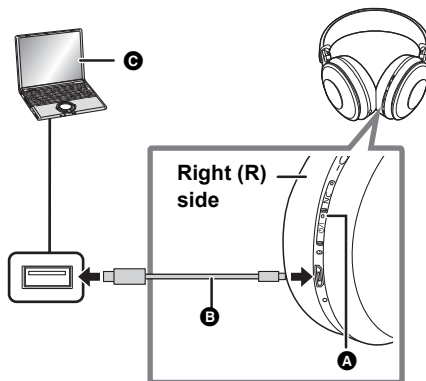

### Note

- Charge in a room temperature between 10 °C and 35 °C (50 °F and 95 °F). Outside of this temperature range, charging may stop and the power/pairing LED may go out.
- It is not possible to turn the power on or connect to Bluetooth® devices during charging.
- Do not use any other USB charging cords except the supplied one. Doing so may cause malfunction.
- Charging may not be performed or may stop if the computer is in or switched to standby or sleep mode.

## Turning the power on/off

In the power-off state, press and hold [**⏻** / **⏸**] of this unit for approx. 3 seconds until the power/pairing LED (blue) blinks.

- A beep will sound, and the power/pairing LED (blue) will blink slowly.

### ■ To turn the power off

Press and hold [**⏻** / **⏸**] for approximately 3 seconds. An English guidance message will be heard, and the power will be turned off.

- It is possible to switch the audio guidance between English and French. (→ 15, "Guidance messages")

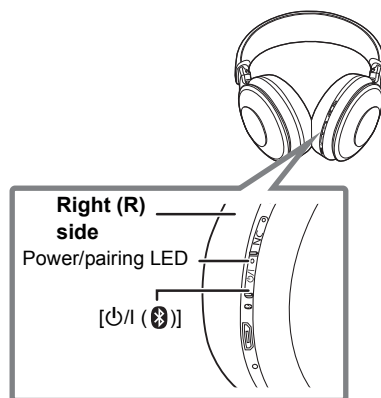

### Note

- If the unit is not connected to a Bluetooth® device, an English guidance message will be heard and turn off the unit automatically approximately 5 minutes after you have stopped using it. (Except for when noise cancelling is turned ON.) (→ 18, "Auto power off")
- It is possible to switch the audio guidance between English and French. (→ 15, "Guidance messages")

# Connecting a Bluetooth® device

## Preparation

- Place the Bluetooth® device within approx. 1 m (3.3 ft.) from the unit.
- Check the device operation using its operation instructions as required.

## Pairing (Registration) this unit with the Bluetooth® device for connection

### 1 In the power-off state, press and hold [⏻/Ⓜ (Ⓜ)] of this unit until the power/pairing LED blinks.

When pairing a device for the first time: approx. 3 seconds

When pairing a second or subsequent devices: approx. 5 seconds

- This unit will start to search for a Bluetooth® device to connect to, and the power/pairing LED will light alternately in blue and red.

### 2 Turn on the power of the Bluetooth® device, and enable the Bluetooth® function.

### 3 Select “EAH-F70N” from the Bluetooth® device’s menu.

- A MAC address (an alphanumeric character string that is displayed by and unique to the device) may be displayed before “EAH-F70N” is displayed.
- If prompted for a passkey, input the passkey “0000 (four zeros)” of this unit.

e.g.

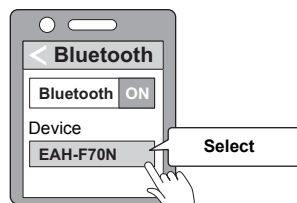

### 4 Check the connection with the Bluetooth® device on the unit.

- The power/pairing LED will light alternately in blue and red until the connection with the device is completed. When the power/pairing LED (blue) blinks twice every approx. 2 seconds, pairing (registration) is completed. (Connection established)

## Note

- If connection to a device is not established within approximately 5 minutes, the unit will be turned off. Perform pairing again. (Except for when noise cancelling is turned ON.)
- You can pair up to 8 Bluetooth® devices with this unit. If a 9th device is paired, the device with the oldest connection will be replaced. To use it, perform pairing again.

---

## Connecting a paired Bluetooth® device

### 1 Turn on this unit.

- Press and hold [ $\text{⏻}$ /I ( $\text{⊗}$ )] of this unit for approx. 3 seconds until the power/pairing LED (blue) blinks.
- A beep will sound, and the power/pairing LED (blue) will blink slowly.

### 2 Perform steps 2 and 3 of “Pairing (Registration) this unit with the Bluetooth® device for connection”. (→ 10)

- When the power/pairing LED (blue) blinks twice every approx. 2 seconds, pairing (registration) is completed. (Connection established)

---

#### Note

- This unit remembers the device lastly connected. Connection may be automatically established after step 1 (see above).
- If connection to a device is not established within approximately 5 minutes, the unit will be turned off. Turn on the unit again. (Except for when noise cancelling is turned ON.)

# Listening to music

If the Bluetooth® compatible device supports the “A2DP” and “AVRCP” Bluetooth® profiles, music can be played back with remote control operations on the unit.

- A2DP (Advanced Audio Distribution Profile): Transmits audio to the unit.
- AVRCP (Audio/Video Remote Control Profile): Allows remote control of the device using the unit.

## 1 Connect the Bluetooth® device and the unit. (→ 10, “Connecting a Bluetooth® device”)

## 2 Select and play the music on the Bluetooth® device.

- The unit’s headphones will output the music or the audio of the video being played back.
- Operating time:  
The maximum playback time is approximately 20 hours. (It may become shorter depending on the usage conditions.)

### ■ Attention

- The unit might leak sound depending on the volume level.
- When the volume is increased to near maximum level, music may sound distorted. Decrease the volume until the distortion is cleared.

## Remote controlling

You can control the Bluetooth® device using the Multiple functions button on the unit.

- Depending on the Bluetooth® device or the app, even if you press the Multiple functions button on the unit, some functions may not respond or may operate differently from the descriptions below.

### (Operation example of the Multiple functions button)

#### Right (R) side

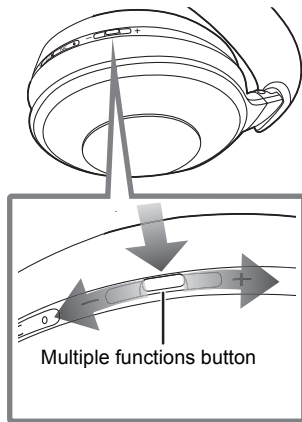

Function	Operation
<b>Play / Pause</b>	Press the Multiple functions button.
<b>Increase the volume</b>	Slide the Multiple functions button towards “+”. • Sliding and holding towards “+” allows you to continuously raise the volume.
<b>Decrease the volume</b>	Slide the Multiple functions button towards “-”. • Sliding and holding towards “-” allows you to continuously lower the volume.
<b>Skip forward</b>	Press the Multiple functions button twice quickly.
<b>Skip backward</b>	Press the Multiple functions button three times quickly.
<b>Fast forward</b>	Press the Multiple functions button twice quickly; hold the second press.
<b>Fast rewind</b>	Press the Multiple functions button three times quickly; hold the third press.

### Note

- The volume can be adjusted in 31 levels (16 levels during calls). When the maximum or minimum volume is reached, a beep will sound.

# Making a phone call

With Bluetooth® enabled phones (cell phones or smartphones) that support the “HSP” or “HFP” Bluetooth® profile, you can use the unit for phone calls.

- **HSP (Headset Profile):**

This profile can be used to receive monaural sounds and establish two-way communication using the microphone on the unit.

- **HFP (Hands-Free Profile):**

In addition to the HSP functions, this profile has the incoming and outgoing calls function.

(This unit does not have a function that allows you to make phone calls independently of a Bluetooth® enabled phone.)

## 1 Connect the Bluetooth® device and the unit. (→ 10, “Connecting a Bluetooth® device”)

## 2 Press the Multiple functions button on the unit and answer the incoming call.

- During an incoming call, ringtone will sound from the unit and the power/pairing LED will blink.
- (HFP only) To reject the incoming call, press the Multiple functions button twice quickly.

Multiple functions  
button



## 3 Start talking.

- The power/pairing LED will repeatedly blink 2 times during a call.
- The volume can be adjusted during a phone call. For setting instructions, see page 12.

## 4 Press the Multiple functions button to end the phone call.

- A beep will sound.

### Note

- There may be instances when hands free setting needs to be done on the Bluetooth® enabled phone.
- Depending on the Bluetooth® enabled phone, you may hear incoming and outgoing call ringtones of the phone from the unit.
- (HFP only) It may be difficult to hear phone conversations when the unit is used in locations with loud ambient noise or in outdoor or other locations exposed to powerful winds. In that case, change the calling location or switch the calling device to the Bluetooth® enabled phone to continue the call. (Press the Multiple functions button on the unit twice quickly to switch.)
- You can have the Bluetooth® enabled phone make phone calls by using the microphone of the unit and an app of the Bluetooth® enabled phone. (→ 15, “Activating voice functions”)

## Using noise cancelling

While using the noise cancelling function, changes the volume and sound quality. The sound quality is set so that it is optimised for each level.

### ■ About noise cancelling level

You can select one of the following levels to suit your preference.

- The default level setting is “Noise cancelling High”.
  - Noise cancelling High
  - Noise cancelling Medium
  - Noise cancelling Low

### 1 Press [NC].

- Each press of [NC] switches between three levels and Off.
  - “Noise cancelling High” —————> “Noise cancelling Medium”
  - ↑
  - “Noise cancelling Off” ←———— “Noise cancelling Low”
  - ↓
- While using the noise cancelling function, the noise cancelling LED lights in green.



### 2 Adjust the volume of the playback device.

#### Note

- While using the noise cancelling function, a very small amount of noise which is generated from the circuit that reduces noise may be heard, but this is normal and not indicative of any trouble. (This very-low-level noise may be heard in quiet places or in the blank parts between tracks.)
- If [NC] is pressed for at least approx. 2 seconds, the audio guidance will announce the current level.
- It is possible to switch the audio guidance between English and French. (→ 15, “Guidance messages”)

# Useful functions

## Activating voice functions

You can use a button on this unit to activate Siri or other voice functions on your smartphone or similar device.

- 1 Connect the Bluetooth® device and the unit. (→ 10, “Connecting a Bluetooth® device”)**
- 2 Press and hold the Multiple functions button on this unit until the voice function is activated.**

### Note

- For details about voice function commands, refer to the operating instructions for the Bluetooth® device.
- The voice function may not work depending on the smartphone, etc., specifications and the app version.

## Guidance messages

The unit is equipped with an a function that provides an audio notification when you turn off the unit, connect a Bluetooth® device or change a setting, for example.

- This unit has English and French messages for the audio guidance.
- The audio guidance function cannot be disabled.
- The audio guidance volume cannot be adjusted.

### ■ Switching the audio guidance language

**Slide and hold the Multiple functions button towards “–” and at the same time press and hold [⏻/Ⓜ] for at least 5 seconds.**

## Using wearing playback

When you take this unit off while playing back music, it automatically pauses. When you put the unit on again, playback of the music resumes.

- This function is available only if your Bluetooth® device supports “AVRCP” Bluetooth® profiles.

The power/pairing LED and noise cancelling LED lights go out when you are wearing this unit.

### ■ To switch this function between enabled and disabled

**Press and hold the Multiple functions button and at the same time press and hold [NC] for at least 5 seconds.**

- When the status is changed to enabled, the power/pairing LED (blue) will light for approx. 2 seconds.
- When the status is changed to disabled, the power/pairing LED (red) will light for approx. 2 seconds.

### Note

- A sensor in the right ear pad detects whether you have the unit on. Wear the unit so your ear fits inside the ear pad.
- Depending on how you wear the unit, under some usage situations (with a hat, hair style, when wet with perspiration, etc.), the temperature, humidity, etc., the sensor may not detect correctly.
- Wearing playback works only while the unit is turned on.
- Depending on the Bluetooth® device or the app, even if the sensor detects correctly, wearing playback may not operate correctly.
- If it does not work correctly, turn off then on again while not wearing this unit.

## Using the ambient sound enhancer

This makes it easier to listen to sounds around you, such as announcements on trains, when you want to, without taking the unit off.

**Place your hand over the ambient sound enhancer sensor panel (R side) (A) so that its entire surface is covered.**

- This makes it easier to listen to sounds around you.
- Noise cancelling will turn OFF temporarily and the volume of the playback sound will be lowered.

The noise cancelling level and the volume return to their original settings when your hand is removed.

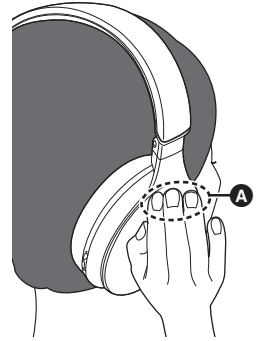

■ **To switch this function between enabled and disabled**

**Slide and hold the Multiple functions button towards “+” and at the same time press and hold [NC] for at least 5 seconds.**

- When the status is changed to enabled, the power/pairing LED (blue) will light for approx. 2 seconds.
- When the status is changed to disabled, the power/pairing LED (red) will light for approx. 2 seconds.

■ **To set this function to always-on mode**

**Press [NC] button twice quickly.**

- To deactivate always-on mode, press the [NC] button, or place your hand over the ambient sound enhancer sensor panel (R side) so that its entire surface is covered and then move the hand away.

### Note

- The ambient sound enhancer works only while the unit is turned on.



## Making a multi-point connection

A Bluetooth® device for music playback and calls (first device) and a Bluetooth® device for calls (second device) can be connected simultaneously.

For example, even when listening to music on the first Bluetooth® device, you can answer calls received on the second Bluetooth® device by setting up the devices as follows.

**For information about the connection and registration of Bluetooth® devices and the unit (→ 10, “Connecting a Bluetooth® device”)**

- 1 Register the unit to both the first Bluetooth® device and the second Bluetooth® device.**
- 2 Connect the first Bluetooth® device, which will be used for music playback, and the unit.**
  - Be sure to connect the Bluetooth® device for music playback first.
- 3 Connect the second Bluetooth® device, which will be used for calls, and the unit.**

---

### Note

- For more details, including more specific setup instructions, refer to the operating instructions for the Bluetooth® devices.
- Only one Bluetooth® device can be connected for music playback.
- When not playing back music on a device running an Android™ OS, etc., disable the “A2DP” setting.
- You can also connect a Bluetooth® device without call functions as the first device to use it for music playback.
- This unit cannot play back music on any Bluetooth® device connected as the second device.
- This unit memorises the last-connected Bluetooth® device. It may connect automatically to reconnect. When reconnecting with the multi-point connection function, turn off the power or Bluetooth® of other Bluetooth® devices until the Bluetooth® device to be used for music playback is reconnected.

## Battery level notification

- When the unit is turned off, an English guidance message will be heard indicating the battery level.
- When the battery level starts to run low, the blinking power/pairing LED will turn from blue to red, and as it drops further, you will be notified by one beep every 1 minute.\* When the battery runs out, an English guidance message will be heard and the power will turn off.
- \* If you press [ $\text{⏻}$ ] / [ $\text{Ⓜ}$ ] twice quickly, an English guidance message will be heard and you can check the battery level.
- It is possible to switch the audio guidance between English and French. (→ 15, "Guidance messages")

## Auto power off

If the unit is not connected to a Bluetooth® device, an English guidance message will be heard and turn off the unit automatically approximately 5 minutes after you have stopped using it.

- It is possible to switch the audio guidance between English and French. (→ 15, "Guidance messages")
- Auto power off does not work when noise cancelling is turned ON.
- Auto power off does not work when the detachable cord (supplied) is connected.

## Using the detachable cord (supplied)

While the power is turned off or the battery has no remaining charge, this unit can be used as normal headphones by connecting the detachable cord (supplied).

- Before connecting the detachable cord (supplied), lower the volume on the connected device.
- If you connect the detachable cord (supplied) during Bluetooth® connection, the Bluetooth® connection will be lost.
- The Multiple functions button does not work even while the unit is turned on.
- Noise may occur due to dirt on the plug. Clean the plug with a soft dry cloth if this occurs.
- Do not use any other detachable cords except the supplied one.

### ■ To connect to an airplane audio system

- 1 **Connect the unit and the detachable cord (supplied). (A)**
- 2 **Connect the input plug (B) of the detachable cord (supplied) to the airplane adaptor (supplied) (C).**
- 3 **Connect the airplane adaptor to the in-airplane audio system. (D)**

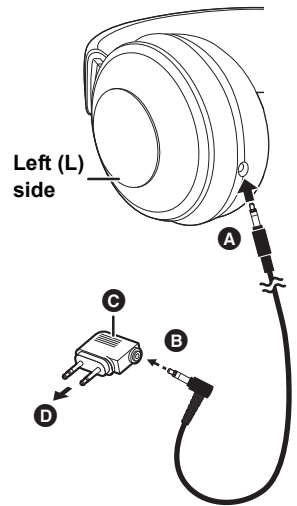

### Note

- The airplane adaptor may not fit the jacks in some in-airplane audio systems.

## Resetting the unit

This unit can be reset when all operations are rejected. To reset the unit, connect the unit to a computer using the USB charging cord. All the previous operations will be cancelled. (The pairing device information will not be deleted.)

## Storage of the unit

Fold the unit as shown below when storing it in the carrying case (supplied).

• If the USB charging cord or the detachable cord (supplied) is connected, disconnect it from the unit.

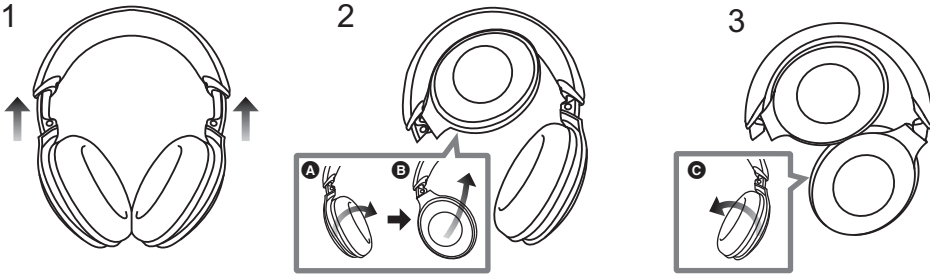

- 1** Store the sliders.
- 2** Rotate the housing on either side by approx. 90° (A) to fold it toward the headband side (B).
- 3** Rotate the other housing by approx. 90° (C).
- 4** Store the unit in the carrying case.

## Restoring to the factory settings

You can restore the unit to the factory settings (original settings upon purchase). Performing the following procedure returns the volume level, noise cancelling level, etc., to the factory settings and deletes the information for all registered devices. Charge the battery before restoring the unit.

- 1 While the power is turned off, press and hold [⏻/Ⓜ (Ⓜ)] for at least 5 seconds until the power/pairing LED lights alternately in blue and red.
- 2 While the power/pairing LED is lighting alternately in blue and red, slide and hold the Multiple functions button towards “+” and at the same time press and hold [⏻/Ⓜ (Ⓜ)] for at least 5 seconds.
  - The default settings will be restored after the power/pairing LED (blue) blinks fast and the unit turns off.

### ■ Attention

- When pairing a device again, delete the registering information (Device: “EAH-F70N”) from the Bluetooth® device’s menu, and register this unit with the Bluetooth® device again. (→ 10)

## Copyright, etc.

The Bluetooth® word mark and logos are registered trademarks owned by Bluetooth SIG, Inc. and any use of such marks by Panasonic Corporation is under license.

Other trademarks and trade names are those of their respective owners.

Siri is a trademark of Apple Inc.

Android is a trademark of Google LLC.

LDAC and LDAC logo are trademarks of Sony Corporation.

Qualcomm aptX is a product of Qualcomm Technologies, Inc. and/or its subsidiaries.

Qualcomm is a trademark of Qualcomm Incorporated, registered in the United States and other countries.

aptX is a trademark of Qualcomm Technologies International, Ltd., registered in the United States and other countries.

Other system names and product names appearing in this document are in general the registered trademarks or trademarks of the respective developer companies.

Note that the ™ mark and ® mark do not appear in this document.

Remove the right ear pad to view certification information. Remove the ear pad by inserting a finger in the inside of the ear pad as if grabbing it, then pulling out. (1)

Certification information is indicated on the speaker plate portion (A), which becomes visible when the right ear pad (R side) is removed. (2)

To attach the ear pad, firstly match the positions of the stitching (B) on the ear pad and the groove (C) on this unit. (3)

Next, press the gather of the ear pad into the channel (D) on this unit. Press in the entire circumference of the gather, including the firm part, and make sure there is no buckling. (4)

Do not pull the ear pad with force when attaching or removing.

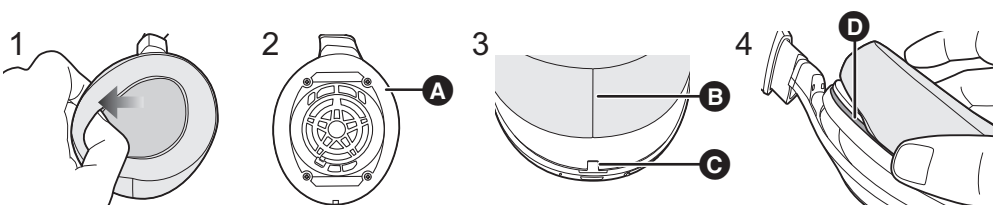

# Troubleshooting

Before requesting service, make the following checks. If you are in doubt about some of the check points, or if the remedies indicated do not solve the problem, consult your dealer for instructions (refer to “Customer Services Directory” on “Basic Owner’s Manual” if you reside in the U.S.A.).

## Sound and audio volume

### No sound.

- Make sure that the unit and the Bluetooth® device are connected correctly. (→ 10)
- Check if music is playing on the Bluetooth® device.
- Make sure that the unit is turned on and the volume is not set too low.
- Pair and connect the Bluetooth® device and the unit again. (→ 10)
- Check if the Bluetooth® compatible device supports “A2DP” profile. For details on profiles, see “Listening to music” (→ 12). Also refer to the operating manual for the Bluetooth® compatible device.
- While playing back music, wearing playback (→ 15) operates correctly when taking the unit off, and playback pauses, but wearing playback may not operate correctly when putting the unit back on and playback may not start. If this happens, operate using the Multiple functions button.

### Cannot adjust the volume.

- Is the ambient sound enhancer operating? Turn off the ambient sound enhancer. (→ 16)
- The Multiple functions button does not work when the detachable cord (supplied) is used.

### Low volume.

- Is the ambient sound enhancer operating? Turn off the ambient sound enhancer. (→ 16)
- Increase the volume of the unit. (→ 12)
- Increase the volume on the Bluetooth® device.

### Sound from the device is cut off. / Too much noise. / Sound quality is bad.

- Sound may be disrupted if signals are blocked. Do not fully cover this unit with the palm of your hand, etc.
- The device may be out of the 10 m (33 ft.) communication range. Move the device closer to this unit.
- Remove any obstacle between this unit and the device.
- Switch off any wireless LAN device when not in use.
- If the unit and the Bluetooth® device are connected via LDAC™, the problem may be solved by changing the sound quality mode on the Bluetooth® device to give priority to connection. For details, refer to the operating instructions for the Bluetooth® device.

## Bluetooth® device connection

### The device cannot be connected.

- You can pair up to 8 Bluetooth® devices with this unit. If a 9th device is paired, the device with the oldest connection will be replaced.
- Delete the pairing information for this unit from the Bluetooth® device, then pair them again. (→ 10)

## Phone Calls

### You cannot hear the person on the other end of the call.

- Make sure that the unit and the Bluetooth® enabled phone are turned on.
- Check if the unit and the Bluetooth® enabled phone are connected. (→ 10)
- Check the audio settings of the Bluetooth® enabled phone. Switch the calling device to the unit if it is set to the Bluetooth® enabled phone. (→ 10)
- If the volume of the other person’s voice is too low, increase the volume of both the unit and the Bluetooth® enabled phone.

### Cannot make a phone call.

- Check if the Bluetooth® compatible device supports “HSP” or “HFP” profile. For details on profiles, see “Listening to music” (→ 12) and “Making a phone call” (→ 13). Also refer to the operating manual for the Bluetooth® enabled phone.

## General

### The unit does not respond.

- This unit can be reset when all operations are rejected. To reset the unit, connect the unit to a computer using the USB charging cord. (→ 18)
- The Multiple functions button does not work when the detachable cord (supplied) is used.

## Power supply and charging

### Cannot charge the unit. / The power/pairing LED does not light during charging. / Charging takes longer.

- Is the USB charging cord connected firmly to the USB terminal of the computer? (→ 9)
- Make sure to charge in a room temperature between 10 °C and 35 °C (50 °F and 95 °F).
- Make sure the computer is turned on and is not on standby or sleep mode.
- Is the USB port you are currently using working properly? If your computer has other USB ports, unplug the connector from its current port and plug it into one of the other ports.
- If the measures mentioned above are not applicable, unplug the USB charging cord and plug it in again.
- It takes approx. 4 hours to charge the battery from empty to full.
- If the charge time and operating time become shortened, the battery may have run down. (Number of charging times of the installed battery: Approximately 300)
- The power/pairing LED lights in red when charging is in progress. When charging is completed, the power/pairing LED will go out.

### The power does not turn on. / The power turns off.

- Is the unit being charged? The power cannot be turned ON during charging. (→ 9)
- The battery is low when the power/pairing LED is blinking in red. Charge the unit.
- Is auto power off active? (→ 18)

## Guidance messages

### The audio guidance language has changed.

- The audio guidance language can be switched. (→ 15)

## Wearing playback

### Wearing playback is not working properly.

- Even when you have put the headphones on correctly, this may not work at times. If this happens, operate using the Multiple functions button.
- The sensor may detect incorrectly whether you have the unit on. Turn the unit off and then on again while it is off your head.

# Specifications

## ■ General

<b>Power supply</b>	DC 5 V, 350 mA (Internal battery: 3.7 V (Li-polymer))
<b>Operating time</b> <sup>*1</sup>	Approx. 20 hours (Noise cancelling: ON, SBC)
<b>Charging time</b> <sup>*2</sup> (25 °C (77 °F))	Approx. 4 hours
<b>Charging temperature range</b>	10 °C to 35 °C (50 °F to 95 °F)
<b>Operating temperature range</b>	0 °C to 40 °C (32 °F to 104 °F)
<b>Operating humidity range</b>	35 %RH to 80 %RH (no condensation)
<b>Mass (Weight)</b>	Approx. 292 g (10.3 oz) (without cord)

\*1 It may be shorter depending on the operating conditions.

\*2 The time required to charge the battery from empty to full.

## ■ Bluetooth® section

<b>Bluetooth® system specification</b>	Ver. 4.2
<b>Wireless equipment classification</b>	Class 2 (2.5 mW)
<b>Max RF power</b>	4 dBm
<b>Frequency band</b>	2402 MHz to 2480 MHz
<b>Supported profiles</b>	A2DP, AVRCP, HSP, HFP
<b>Supported codec</b>	SBC, AAC, Qualcomm® aptX™, Qualcomm® aptX™ HD, LDAC
<b>Operating distance</b>	Up to 10 m (33 ft.)

## ■ Headphone section

<b>Impedance</b>	28 Ω (Power off, with cord)
<b>Max input</b>	1000 mW (IEC)
<b>Frequency response</b>	4 Hz to 40000 Hz (with cord)

## ■ Speaker section

<b>Driver units</b>	40 mm (1 - 9/16 inch)
---------------------	-----------------------

## ■ Terminal section

<b>DC IN</b>	DC 5 V, 350 mA
--------------	----------------

## ■ Microphone section

<b>Type</b>	Mono
-------------	------

## ■ Accessory section

<b>USB charging cord</b>	Approx. 0.5 m (1.6 ft.)
<b>Detachable cord</b>	Approx. 1.2 m (3.9 ft.)
<b>Carrying case</b>	
<b>Airplane adaptor</b>	

• Specifications are subject to change without notice.

## To remove the battery when disposing of this unit

The following instructions are not intended for repairing purposes but for the disposal of this unit. This unit is not restorable once disassembled.  
 • When disposing of this unit, take out the battery installed in this unit and recycle it.

- Disassemble after the battery runs out.
- Keep disassembled parts out of reach of children.

### Regarding the handling of used battery

- Insulate the terminals with adhesive tape or similar material.
- Do not disassemble.

### ■ Battery

- Do not heat or expose to flame.
- Do not leave the battery in a car exposed to direct sunlight for a long period of time with doors and windows closed.
- Battery mishandling can cause electrolyte leakage which can damage items the leaked fluid comes into contact with. If electrolyte leaks from the battery, consult your dealer. Wash thoroughly with water if electrolyte comes in contact with any part of your body.
- When disposing of the battery, please contact your local authorities or dealer and ask for the correct method of disposal.

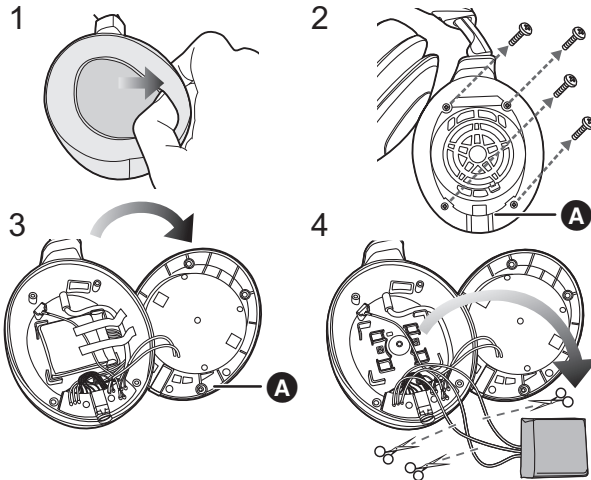

- 1 Remove the left ear pad. Remove the ear pad by inserting a finger in the inside of the ear pad as if grabbing it, then pulling out.
- 2 Peel off the 4 screw hole stickers and remove the 4 screws.
- 3 Remove the part **A** in step 2.
- 4 Peel off the tape fixing the battery in place, remove the battery, and cut off the wires one by one with scissors.



**Declaration of Conformity (DoC)**

Hereby, "Panasonic Corporation" declares that this product is in compliance with the essential requirements and other relevant provisions of Directive 2014/53/EU.

Customers can download a copy of the original DoC to our RE products from our DoC server:

<http://www.ptc.panasonic.eu>

Contact to Authorised Representative:

Panasonic Marketing Europe GmbH,

Panasonic Testing Centre, Winsbergring 15, 22525 Hamburg, Germany

Type of wireless	Frequency band	Maximum power
Bluetooth®	2402 - 2480 MHz	4 dBm

**Disposal of Old Equipment and Batteries****Only for European Union and countries with recycling systems**

These symbols on the products, packaging, and/or accompanying documents mean that used electrical and electronic products and batteries must not be mixed with general household waste. For proper treatment, recovery and recycling of old products and used batteries, please take them to applicable collection points in accordance with your national legislation.

By disposing of them correctly, you will help to save valuable resources and prevent any potential negative effects on human health and the environment.

For more information about collection and recycling, please contact your local municipality. Penalties may be applicable for incorrect disposal of this waste, in accordance with national legislation.

**(Note for the battery symbol (bottom symbol)):**

This symbol might be used in combination with a chemical symbol. In this case it complies with the requirement set by the Directive for the chemical involved.



Qualcomm®  
aptX™ HD



Manufactured by: Panasonic Corporation  
Kadoma, Osaka, Japan  
Importer for Europe: Panasonic Marketing Europe GmbH  
Panasonic Testing Centre  
Winsbergring 15, 22525 Hamburg, Germany



---

**Panasonic Corporation**  
<http://www.panasonic.com>

**For the U.S.A.**

Panasonic Corporation of North America  
Two Riverfront Plaza, Newark, NJ 07102-5490  
<http://shop.panasonic.com>

